

General Warranty

We warrant that the product will be free from defects in materials and workmanship for a period of 3 years (1 year for accessories) from the date of purchase of the product by the original purchaser from the our Company. This warranty only applies to the original purchaser and is not transferable to the third party.

If the product proves defective during the warranty period, we either will repair the defective product without charge for parts and labor, or will provide a replacement in exchange for the defective product. Parts, modules and replacement products used by our company for warranty work may be new or reconditioned like new performance. All replaced parts, modules and products become the property of our company.

In order to obtain service under this warranty, customer must notify our company of the defect before the expiration of the warranty period. Customer shall be responsible for packaging and shipping the defective product to the service center designated by our company, and with a copy of customer proof of purchase.

This warranty shall not apply to any defect, failure or damage caused by improper use or improper or inadequate maintenance and care. We shall not be obligated to furnish service under this warranty a) to repair damage resulting from attempts by personnel other than our company representatives to install, repair or service the product; b) to repair damage resulting from improper use or connection to incompatible equipment; c) to repair any damage or malfunction caused by the use of not our company supplies; or d) to service a product that has been modified or integrated with other products when the effect of such modification or integration increases the time or difficulty of servicing the product.

Please contact the nearest Sales for services.

Excepting the after-sales services provided in this summary or the applicable warranty statements, we will not offer any guarantee for maintenance definitely declared or hinted, including but not limited to the implied guarantee for marketability and special-purpose acceptability. We should not take any responsibilities for any indirect, special or consequent damages.

※: The illustrations, interface, icons and characters in the user manual may be slightly different from the actual product. Please refer to the actual product.

Table of Contents

| | |
|---|----|
| 1. General Safety Requirement | 1 |
| 2. Safety Terms and Symbols | 2 |
| 3. General Inspection | 3 |
| 4. Quick Start | 4 |
| Front panel overview | 4 |
| Rear Panel Overview | 6 |
| Power on | 7 |
| User Interface | 8 |
| Use build-in Help | 9 |
| Set the channel | 9 |
| Set basic waveform | 9 |
| Output the build-in waveform (including AC) | 11 |
| Edit the arbitrary waveform | 11 |
| Output Mod Waveforms | 12 |
| Output Sweep Waveform | 13 |
| Output Burst Waveform | 13 |
| Counter | 14 |
| File Store System | 15 |
| Save the current arbitrary wave | 15 |
| Bring up arbitrary wave files in internal/external memory | 16 |
| Clear waveform from memory | 16 |
| Save/recall instrument preset | 17 |
| Utility Setting | 17 |
| 5. Communicate with PC | 20 |
| Using USB Port | 20 |
| Using LAN Port | 20 |
| Connect Directly | 20 |
| Connect through a Router | 21 |
| 6. Appendix | 23 |
| Appendix A: Accessories | 23 |
| Appendix B: General Care and Cleaning | 23 |

1. General Safety Requirement

Before use, please read the following safety precautions to avoid any possible bodily injury and to prevent this product or any other connected products from damage. In order to avoid any contingent danger, ensure this product is only used within the range specified.

Only the qualified technicians can implement the maintenance.

To avoid Fire or Personal Injury:

- **Use Proper Power Cord.** Use only the power cord supplied with the product and certified to use in your country.
- **Product Grounded.** This instrument is grounded through the power cord grounding conductor. To avoid electric shock, the grounding conductor must be grounded. The product must be grounded properly before any connection with its input or output terminal.
- **Check all Terminal Ratings.** To avoid fire or shock hazard, check all ratings and markers of this product. Refer to the user's manual for more information about ratings before connecting to the instrument.
- **Do not operate without covers.** Do not operate the instrument with covers or panels removed.
- **Use Proper Fuse.** Use only the specified type and rating fuse for this instrument.
- **Avoid exposed circuit.** Do not touch exposed junctions and components when the instrument is powered.
- **Do not operate if in any doubt.** If you suspect damage occurs to the instrument, have it inspected by qualified service personnel before further operations.
- **In well-ventilated area.** Make sure the instrument installed with proper ventilation, refer to the user manual for more details.
- **Do not operate in wet conditions.**
- **Do not operate in an explosive atmosphere.**
- **Keep product surfaces clean and dry.**

2. Safety Terms and Symbols

Terms in this Manual. The following terms may appear in this manual:

 **Warning:** Warning indicates the conditions or practices that could result in injury or loss of life.

 **Caution:** Caution indicates the conditions or practices that could result in damage to this product or other property.

Terms on the Product. The following terms may appear on this product:

Danger: It indicates an injury or hazard may immediately happen.

Warning: It indicates an injury or hazard may be accessible potentially.

Caution: It indicates a potential damage to the instrument or other property might occur.

Safety Symbols

Symbols on the Product. The following symbol may appear on the product:

 Hazardous Voltage

 Refer to Manual

 Protective Earth Terminal

 Chassis Ground

 Test Ground

3. General Inspection

After you get a new multimeter, it is recommended that you should make a check on the instrument according to the following steps:

1. Check whether there is any damage caused by transportation.

If it is found that the packaging carton or the foamed plastic protection cushion has suffered serious damage, do not throw it away first till the complete device and its accessories succeed in the electrical and mechanical property tests.

2. Check the Accessories

The supplied accessories have been already described in the Appendix A: Enclosure of this Manual. You can check whether there is any loss of accessories with reference to this description. If it is found that there is any accessory lost or damaged, please get in touch with the distributor of our company responsible for this service or the our company local offices.

3. Check the Complete Instrument

If it is found that there is damage to the appearance of the instrument, or the instrument can not work normally, or fails in the performance test, please get in touch with the our company distributor responsible for this business or the our company local offices. If there is damage to the instrument caused by the transportation, please keep the package. With the transportation department or our company distributor responsible for this business informed about it, a repairing or replacement of the instrument will be arranged by our company.

4. Quick Start

Front panel overview

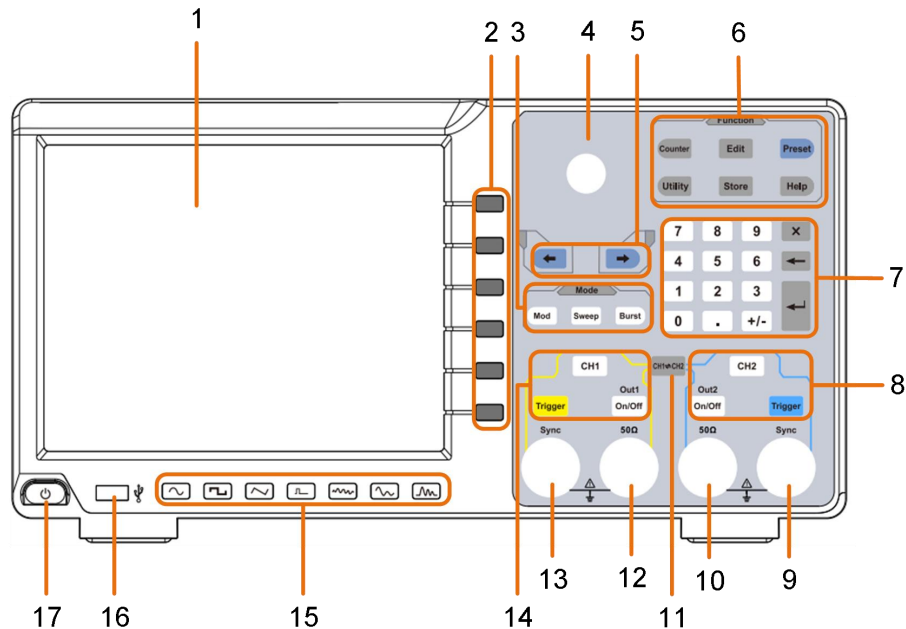









Figure 4- 1 Front Panel overview

| | | |
|---|----------------------------|--|
| 1 | LCD | Display the user interface. |
| 2 | Menu selection keys | Includes 6 keys to activate the corresponding menu. |
| 3 | Mode keys | Mod: output the modulated waveform. Sweep: scan the sine, square,ramp or arbitrary waveforms Burst: generate the sine, square, ramp, pulse or arbitrary burst. |
| 4 | Knob | Change the currently selected value, also used to select the character in the soft keyboard when the file location or file name is entered. When inserting a USB flash drive, press the knob to save the current display screen to the folder of the USB flash drive in BMP image format. |
| 5 | Direction key | Move the cursor of the selected parameter. |
| 6 | Operation keys | Counter: enter the counter interface. Edit: enter the wavform edit interface. Preset: enter the preset menu, set the reset parameter or |

| | | |
|----|--|---|
| | | power-on parameter; save or load the setting file. |
| | | Utility: set the utility function. |
| | | Store: save/load arbitrary waveform. |
| | | Help: To get contextual help for any front panel button or menu softkey, press the button and then press the button for which you need help. |
| 7 | Number keypad | Input the parameter. |
| 8 | CH2 Function keys | <p>CH2 button: After entering the waveform interface and selecting the CH2 channel (the backlight of the button is illuminated), the waveform and parameters of CH2 can be set after selection.</p> <p>Blue Trigger button: CH2 manual trigger button. In sweep or burst mode, when the trigger source is selected as “Manual”, each press of this button will initiate a trigger.</p> <p>On/Off button: Turns the output of the CH2 channel on or off. When the output is turned on, the backlight of the button lights up.</p> |
| 9 | CH2 synchronous output terminal | When Utility → CH1/2 set → CH2 Sync turned on, this terminal outputs a synchronization message that matches the current configuration of CH2. |
| 10 | CH2 output terminal | Output CH2 signal. |
| 11 | CH1⇌CH2 button | Display the channel copy menu. |
| 12 | CH1 output | Output CH1 signal. |
| 13 | CH1 synchronous output terminal | When Utility → CH1/2 set → CH1 Sync turned on, this terminal outputs a synchronization message that matches the current configuration of CH2. |
| 14 | CH1 Function keys | <p>CH1 button: After entering the waveform interface and selecting the CH1 channel (the backlight of the button is illuminated), the waveform and parameters of CH1 can be set after selection.</p> <p>Yellow Trigger button: CH1 manual trigger button. In sweep or burst mode, when the trigger source is selected as “Manual”, each press of this button will initiate a trigger.</p> |

| | |
|-----------------------------------|--|
| | On/Off button: Turns the output of the CH1 channel on or off. When the output is turned on, the backlight of the button lights up. |
| 15 Waveform Selection area | Includes: Sine  , Square  , Ramp  , Pulse  , Noise  , Arb Wave  , Harmonic Wave  . When a waveform is selected, the corresponding backlight is lit. |
| 16 USB interface | Connect with external USB devices, e.g. U disk. |
| 17 Power button | Turn on/off the waveform generator. |

Rear Panel Overview

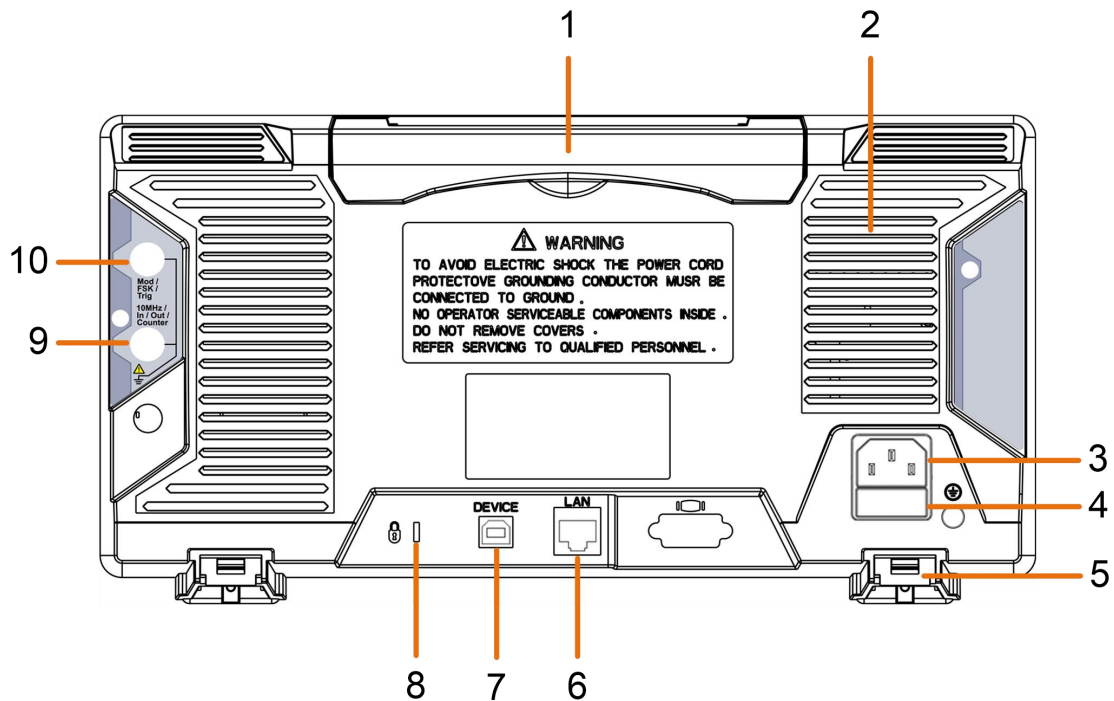

Figure 4- 2 Rear Panel Overview

| | |
|-----------------------------|--|
| 1 Retractable handle | |
| 2 Air vents | |
| 3 AC input connector | AC input connector. |
| 4 Fuse Container | The place to install the fuse. |
| 5 Foot Stool | Tilt the signal generator for easy operation. |
| 6 LAN interface | the network port which can be used to connect with PC. |

| | | |
|----|---|---|
| 7 | USB Device interface | Used to connect a USB type B controller. Can be connected with PC, the signal generator can be controlled by the host computer software. |
| 8 | Lock Hole | You can lock the device to a fixed location using the security lock (please buy it yourself) to secure the device. |
| 9 | 10MHz/In/Out/Counter (refer to clock input/output/counter input) connector | It is default to receive the frequency meter input signal. Used to receive a 10MHz clock signal when the instrument is set to an internal clock source and Utility → System → CLK Output is turned on; it is used to receive an external 10MHz clock signal when the instrument is set to an external clock source. |
| 10 | Mod/FSK/Trig (modulation/trigger input) connector | <p>When modulating the waveform, outputting the sweep frequency, and outputting the burst, the signal accessed here can be used as an external source.</p> <p>Note: If one channel turns on AM, FM, PM, PWM or OSK, and the other channel turns on ASK, FSK, PSK, sweep or burst, and both channels are set to external trigger, then the channel that sets the trigger source can be accessed to external trigger, the other channel automatically cancels the external trigger because of the different external modulation signal types.</p> |

Power on

- (1) Connect the instrument to an AC power source using the power cord supplied with the accessory.



Warning:

To prevent electric shock, make sure the instrument is properly grounded.

- (2) Press the **power button** on the front panel. The startup screen will display.

User Interface

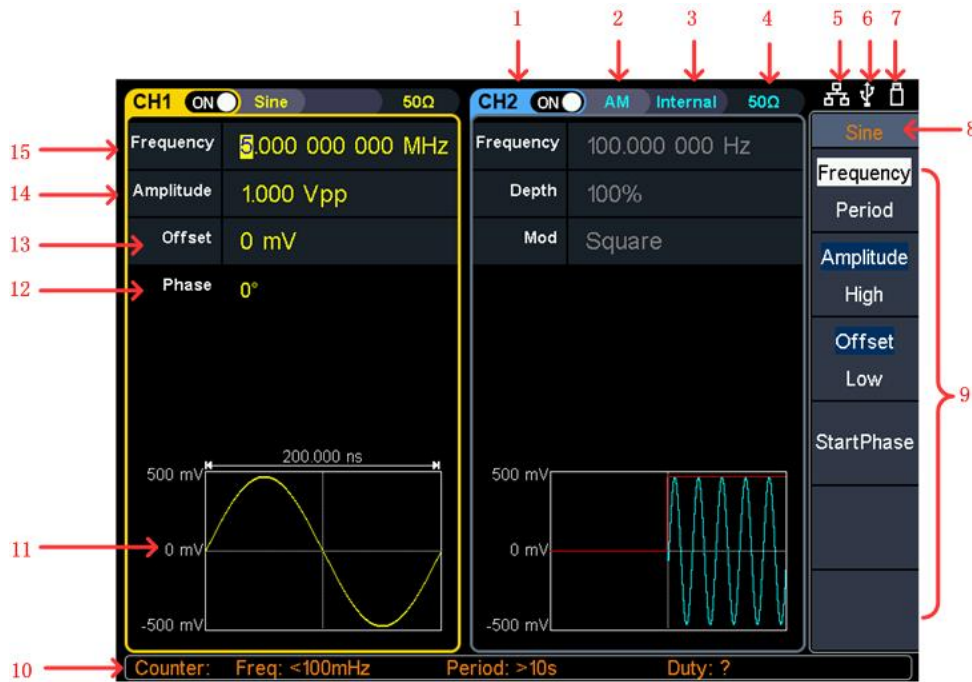

Figure 4-3 User Interface

-
- 1 Display channel name and channel switch status.

 - 2 Current waveform or current mode.

 - 3 Trigger source
Internal: Internal modulation or internal trigger source;
External: External modulation or external trigger source;
Manual: Manual trigger source.

 - 4 Load, High Z indicates high resistance.

 - 5 This indicator is lit when the network is connected through the LAN interface.

 - 6 Lights up the indicator when connected to the USB Host via the USB DEVICE interface.

 - 7 When the instrument detects the USB flash drive, it lights up the indicator.

 - 8 Current menu name.

 - 9 Current waveform or mode setting menu.

 - 10 Counter brief information showing frequency value, period value.

 - 11 Display current waveform.

 - 12 Start phase.

 - 13 Offset / low level, depending on the right highlighted menu item.

14 Amplitude / high level, depending on the right highlighted menu item.

15 Frequency/cycle, depending on the highlighted menu item on the right.

Use build-in Help

- (1) To get help on any front panel button or menu softkey, first press the front panel **Help** function button, then press the button you need help with.
- (2) Press the **Help** function key again to exit the help interface.

Set the channel

- **Select the channel for configuration**

Before configuring waveform parameters, you must first select the channel you want to configure. Press **CH1** or **CH2** to select the corresponding channel, and the corresponding channel area in the user interface will light up.







- **Turn on/off channel output**

Press CH1 **On/Off** or CH2 **On/Off** on front page to turn on/off the corresponding channel output. The channel will light up when it is set to output.

- **Channel copy**

- (1) Press the front panel **CH1⇌CH2** button to display the channel copy menu.
- (2) Select CH2 to CH1 or CH1 to CH2 to copy the channel.

Set basic waveform

Can set and output the Sine, Square, Ramp, Pulse, Noise, Arbitrary or Harmonic waveform. Press the waveform selection button on the front panel of the instrument: sine , square , ramp , pulse , noise , arbitrary , harmonic , and enter the corresponding waveform setting interface. The waveform is different and the parameters that can be set are different.

Example: Press the  key and press the **frequency/period** soft key. The selected menu item is highlighted on white, and the cursor will display on corresponding parameter item in the user interface. Press the

frequency/period softkey to switch the frequency/period.

There are two ways to change the selected parameter value:

- Turn the **Knob** to increase or decrease the value at the cursor. Press the arrow keys to move the cursor left or right.
- Press a **number key** on the numeric keypad directly, the screen will pop out of the data input box, continue to input the desired value. Press the  key to delete the last digit. Press the right menu soft key to select the unit of the parameter. Press the **Cancel** softkey to cancel the current entry.

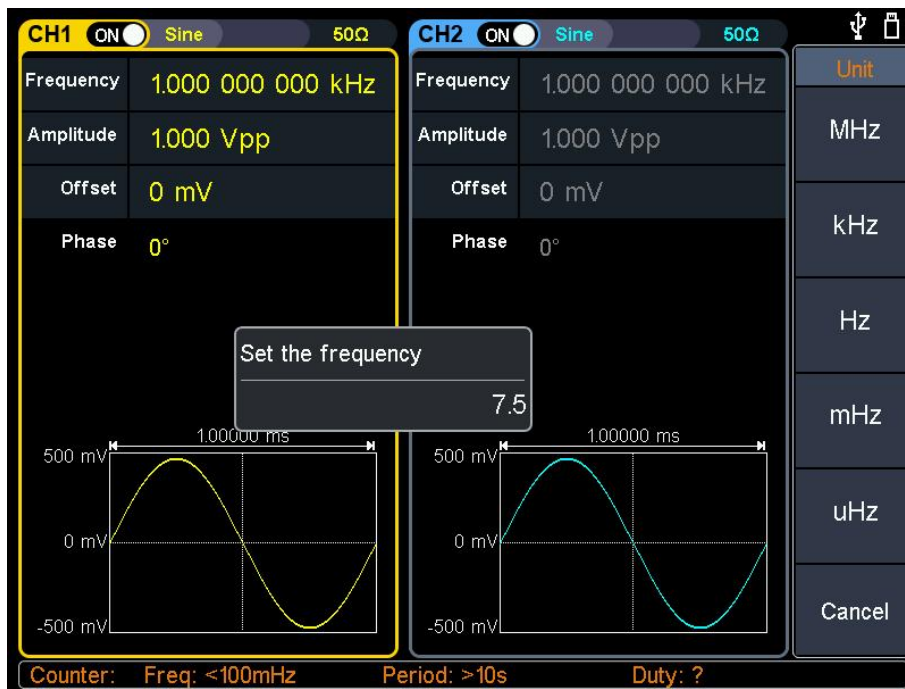



Figure 4-4: Use numeric keypad to set the frequency

Available parameter for each kinds of waveform:

| Waveform | Waveform menu |
|-----------|--|
| Sine | Frequency/Period, Amplitude/High, Offset/Low, StartPhase |
| Square | Frequency/Period, Amplitude/High, Offset/Low, StartPhase |
| Ramp | Frequency/Period, Amplitude/High, Offset/Low, StartPhase, Symmetry |
| Pulse | Frequency/Period, Amplitude/High, Offset/Low, StartPhase, Width/DutyCyc, Rising/Falling |
| Noise | Amplitude/High, Offset/Low |
| Arbitrary | Frequency/Period, Amplitude/High, Offset/Low, StartPhase, Bult-in |
| Harmonic | Frequency/Period, Amplitude/High, Offset/Low, StartPhase, Type/Sequential, Order, SN, Amplitude, Phase |

Output the build-in waveform (including AC)

- (1) Press the  Arbitrary Wave button to enter the Arbitrary Wave menu and configure the waveform parameters.
- (2) Press the **Built-in** softkey, the build-in waveform type menu will pop out.
- (3) Press the **Common**, **Seg Mod**, **Medical Treatment**, **Standard**, **Maths**, **Trigonometric**, **Window Function**, and **Engineering** softkey to enter a detailed list of categories.
- (4) Rotate the **Knob** and select the file in the list, and press the **OK** software.

Note: DC is a type of built-in waveform, located in the "Common" category of "DC".

Edit the arbitrary waveform

Press the front panel **Edit** function key to enter the arbitrary wave editing interface.

- (1) **Set the number of waveform points:** Press the **number of waveform points** softkey, use the **knob** to change the value directly or use the **numeric keypad** to input and select the unit softkey. The number of points ranges from 2 to 100,000.
- (2) **Select a template:** Press the **Basic Template** softkey to select blank, sine, square, ramp, and noise. Press the **Arb Template** softkey to select common、Medical treatment、Standard、Maths, and press **NextPage** to select Trigonometric、Window function、Engineering and Seg Mod.
- (3) **Edit Waveform Point:** Press to **edit the waveform point** to enter the Edit Waveform Point menu.
 - Select the **number of points** and enter the number of the point you want to set.
 - Select the **Voltage** and enter the voltage value to be set at this point.
 - Repeat this step to set all the points you want to set.
 - Press **Store** to enter the file system interface.
 - Press **Date to CH1** ,the current waveform is updated to channel 1; Press **Date to CH2** ,the current waveform is updated to channel 2.
 - If you want to save the waveform to the built-in memory, check **INTER** and press **Set File** softkey. Turn the knob to select one of the **USER** files (EditMemory cannot be selected) and press the **Save** softkey. (The file size

is displayed on the right side of the USER file. If 0B is displayed, it means the file is empty.)

- ◆ **Description:** EditMemory is a temporary data space created, saved, edited or recalled by any arbitrary wave. Saving the waveform is to save the data of this space to the user-specified location (EditMemory is in the memory and never empty). The data in this space is changed after an arbitrary waveform is called, a new waveform is created, or a related programming command is received.
- If you want to save to a USB storage device, you need to plug the USB storage device into the front panel USB interface. Turn the knob to select USBDEVICE. Press to **Arb file** softkey and the instrument will list the directories of the folders and files in the USB storage device. You can turn the knob to select a folder or file. Press to **Enter** the softkey to enter the currently selected folder. To return to the parent directory, press the **Back** softkey. After selecting the storage path, press the **Save As** softkey and the input keyboard appears on the screen. Turn the knob to select a character. Press the **ABC/abc** softkey to toggle the case of keyboard characters. Press the **Select** softkey to enter the current character. Press the **Delete** softkey to delete the last character that has been entered. Press the **Done** softkey to finish editing, and the waveform will be saved in the current path with the file suffixed by bin.

Output Mod Waveforms

Supported modulation types include: AM (amplitude modulation), FM (frequency modulation), PM (phase modulation), PWM (pulse width modulation), ASK (amplitude shift keying), PSK (phase shift keying), FSK (frequency shift keying), 3FSK (ternary frequency shift keying), 4FSK (quadrature frequency shift keying), BPSK (biphase phase shift keying), QPSK (quadrature phase shift keying), OSK (oscillating keying).

Press the **Mod** function key, press the **Type** softkey, turn the **Knob** to select the modulation type, and press the **OK** soft key to enter the setup menu. To turn off modulation, press the **Mod** function button again.

The parameters can be set for each modulation type:

| Modulation | Parameter can be set | |
|------------|----------------------|---|
| AM | Internal source | waveform modulation, frequency modulation, depth modulation |
| | External source | |
| FM | Internal source | waveform modulation, frequency modulation, frequency offset |
| | External source | Frequency offset |

| | | |
|------|---|---|
| PM | Internal source | waveform modulation, frequency modulation, phase deviation |
| | External source | Phase deviation |
| PWM | Internal source | waveform modulation, frequency modulation, duty cycle deviation |
| | External source | Duty cycle deviation |
| ASK | Internal source | Waveform modulation, ASK rate, amplitude |
| | External source | Slope, amplitude |
| PSK | Internal source | Waveform modulation, PSK rate, phase deviation |
| | External source | Slope, phase deviation |
| FSK | Internal source | FSK rate, frequency hopping |
| | External source | Slope, frequency hopping |
| 3FSK | FSK rate, frequency hopping 1, frequency hopping 2 | |
| 4FSK | FSK rate, frequency hopping 1, frequency hopping 2, frequency hopping 3 | |
| BPSK | Bit rate, phase deviation, data source | |
| QPSK | Rate, phase1, phase2, phase3 | |
| OSK | Key frequency, vibration time | |

Output Sweep Waveform

In the sweep mode, the output changes from the start frequency to the end frequency within the specified scan time. Sweep waveforms can only be generated using sine, square, ramp or arbitrary waves.

In the sine, square, ramp or arbitrary wave interface, press the front panel **Sweep** key to enter the sweep mode (the backlight of the button lights up). The parameters that can be set are: scan time, linear scan/log scan, start frequency/center frequency, stop frequency/frequency range, trigger source.

Output Burst Waveform

Press the **Burst** key on the front panel to generate a burst waveform output for a variety of waveform functions. The burst can last for a specific number of waveform cycles (N-cycle bursts) or be controlled by an external gate signal (gated burst). The sine, square, ramp, pulse, or arbitrary wave function can be used (this function cannot be used for noise).

Pulse cycle, cycle number/infinite, trigger source can be set in N cycle mode.

Polarity can be set in gate mode.

Counter

The frequency counter measures signals in the frequency range from 100 mHz to 200 MHz. The **[10MHz In/Out/Counter]** connector on the rear panel is used by default to receive the frequency counter input signal. The frequency meter works from the start, unless the connector is set to an external clock input or clock output.

- (1) Press the front panel **Counter** function key to enter the frequency counter interface.
- (2) Connect the signal to be tested to the **[10MHz In/Out/Counter]** connector on the rear panel.
- (3) Set the frequency counter:
 - Press the **Coupling** soft key to switch between AC and DC , to set the coupling mode of the input signal.
 - Press the **Sensitivity** softkey to toggle between low, middle or high. For small amplitude signals, the sensitivity is selected to be middle or high. For low frequency large signals or signals with slow rising edges, low sensitivity is selected and the measurement results are more accurate.
 - Press the **HFR** soft key to toggle ON or OFF high frequency rejection. High-frequency rejection can be used to filter high-frequency factors when measuring low-frequency signals, improving measurement accuracy. When measuring low frequency signals with a frequency less than 1 kHz, turn on high frequency rejection to filter out high frequency noise interference; turn off high frequency rejection when measuring high frequency signals with frequencies greater than 1 kHz.
 - Press the **Trigger Level** softkey. Turn the **knob** to change the current cursor position value, press the arrow keys to move the cursor left or right; or use the **numeric keypad** to enter a value and then select the desired unit from the right menu. The trigger level ranges from -2.5 V to 2.5 V.

After the setting is completed, the frequency counter will measure the signal to be tested at the current setting. If the reading is unstable, repeat the above adjustment until the display is stable.

- (4) The frequency, period, duty cycle, positive pulse width, and negative pulse width can be viewed on the frequency meter interface. If it is not currently in frequency counter interface, the frequency, period and duty cycle can be viewed in the frequency counter bar at the bottom of the screen.

File Store System

File system memory is divided into internal memory (INTER) and removable memory (USBDEVICE). When a USB device is connected, the main interface displays INTER and USBDEVICE. If no USB device is connected, only the internal memory INTER is displayed. The internal memory can store 32 arbitrary waveform data.

Press the front panel **Store** function key to enter the file system.

Save the current arbitrary wave

- (1) Press the  button to enter the Arbitrary Wave menu and configure the waveform parameters.
- (2) Press the front panel **Store** function key to enter the file system.
 - If you want to save the current arbitrary waveform to the built-in memory, select INTER and press to **Set File** the softkey. Turn the knob to select one of the USER files (EditMemory cannot be selected) and press the **Save** softkey. (The file size is displayed on the right side of the USER file. If 0B is displayed, it means the file is empty.)

Description: EditMemory is a temporary data space created, saved, edited or recalled by any arbitrary wave. Saving the waveform is to save the data of this space to the user-specified location (EditMemory is in the memory and never empty). The data in this space is changed after an arbitrary waveform is called, a new waveform is created, or a related programming command is received.

- If you want to save to a USB storage device, you need to plug the USB storage device into the front panel USB interface. Turn the knob to select USBDEVICE. Press to **Arb file** softkey and the instrument will list the directories of the folders and files in the USB storage device. You can turn the knob to select a folder or file. Press to **Enter** softkey to enter the currently selected folder. To return to the parent directory, press the **Back** softkey.
- After selecting the storage path, press the **Save As** softkey and the input keyboard appears on the screen. Turn the knob to select a character. Press the **ABC/abc** softkey to toggle the case of keyboard

characters. Press the **Select** softkey to enter the current character. Press the **Delete** softkey to delete the last character that has been entered. Press the **Done** softkey to finish editing, and the waveform will be saved in the current path in a file format such as bin.

Bring up arbitrary wave files in internal/external memory

Press the front panel **Store** function key to enter the file system.

- To call up the waveform file in the internal memory, select **INTER** under the memory selection interface and press to **Set File** the soft key. Turn the knob to select a file and press the **CallOut** softkey. If the reading is successful, the screen will prompt “File Read Successful”.
- ◆ **Description:** The file size is displayed on the right side of the file. If 0B is displayed, the file is empty.
- To recall the waveform file in the USB storage device, turn the knob to select USBDEVICE in the memory selection interface. Press the **Arb file** softkey and the instrument will list the directories of the folders and files in the USB storage device. Turn the knob to select a folder or file. Select the file with the suffix of bin and press the **CallOut** softkey. If the reading is successful, the screen will prompt “File Read Successful”. Press the **Save As** softkey, a softkey board will appear on the screen interface. We can use the front panel knob to rotate left or right or the right menu softkey to create and name files.
- Copy the waveform file from the USB storage device to internal memory:
After the waveform file in the USB storage device is called up according to the previous step, press the **Back** soft key to return to the upper directory. After returning to the memory selection interface, turn the knob to select INTER and press the **Enter** softkey. Turn the knob to select a USER file and press the **Save** button to copy the waveform file to the internal memory.
- ◆ **Description:** In the arbitrary waveform interface, Shape displays the storage location or waveform name of the current arbitrary waveform. USER indicates the internal memory, External indicates the USB storage device, and if it is a built-in waveform, the built-in waveform name is displayed.

Clear waveform from memory

- (1) Press the front panel **Store** function key to enter the file system.
- (2) Select INTER under the memory selection interface and press to **Set File**

the softkey.

- (3) Press the **Security** softkey, the screen pops up, and then press the **OK** soft key to clear all waveforms in the internal memory.

Save/recall instrument preset

The instrument settings can be saved as files in internal memory or on an external USB storage device. Up to 16 instrument settings can be saved in the instrument's internal memory. To save more settings, use a USB storage device. The settings file saved to the USB storage device uses the extension CFG. The saved settings can be restored from files in the internal memory or USB storage device.

Operation Step:

Press the front panel **Preset** function key to enter the preset menu, and press the **Store** softkey to enter the memory selection interface.

- If you want to save the settings to the built-in memory, check **INTER** and press the **Set File** softkey. Turn the knob to select a Setup file and press the **Save** softkey. (The file size is displayed on the right side of the Setup file. If 0B is displayed, it means the file is empty.)

Note: Press the **Security** softkey and press the **OK** softkey to clear all settings in the internal memory.

- If you want to save to a USB storage device, you need to plug the USB storage device into the front panel USB interface. Turn the knob to select **USBDEVICE**. Press to **Arb file** the softkey and the instrument will list the directories of the folders and files in the USB storage device. You can turn the knob to select a folder or file. Press to **enter** the softkey to enter the currently selected folder. To return to the parent directory, press the **Back** softkey.

After selecting the storage path, press the **Save As** softkey and the input keyboard appears on the screen. Turn the knob to select a character. Press the **ABC/abc** softkey to toggle the case of keyboard characters. Press the **Select** softkey to enter the current character. Press the **Delete** softkey to delete the last character that has been entered. Press the **Done** softkey to complete the editing. The current instrument settings will be saved in the current path in the cfg file format.

- To recall the settings, select the desired file and press to **CallOut** the softkey.

Utility Setting

Press the front panel **Utility** function key to enter the system options menu.

The user can set the display parameters of the signal generator, CH1/2 parameters, interface parameters and system parameters. Press **Utility** again to exit the system options menu.

Utility system menu

| Menu | Description |
|------------------------|---|
| Display Setting | |
| Backlight | Set the parameter value of the screen brightness. |
| Screen saver | Screen saver time range between 1 to 999 minutes. |
| Separator | Set the separator for the screen display data. |
| Date | Set the current date and time of the system. |
| CH1/2 Setting | |
| CH1 Sync | Enable/disable front panel CH1 sync output terminal to output sync signal. |
| CH2 Sync | Enable/disable front panel CH2 sync output terminal to output sync signal. |
| CH1 Load | It is convenient for the user to match the display voltage with the desired load. The range is from 1 Ω to 10 K Ω . |
| CH2 Load | |
| I/O Setting | |
| USB Device | Set the communication protocol type of the USB Device interface on the rear panel. PC: This is the internal communication protocol. Select this option when connecting to the Waveform Editor host computer software via the USB Device interface. USBTMC: Select this when you need to use the USBTMC communication protocol standard. |
| Network | Network parameters while communicating with a computer using a LAN interface |
| System Setting | |
| Language | Select instrument interface language. |
| Beeper | If ON, it makes sounds when prompted. |
| CLK Ref | Internal or external. |
| CLK Output | When the instrument is set to the internal clock reference, it can be switched on or off . When the selection is turned on , the rear panel [10MHz In/Out/Counter] connector outputs a 10MHz clock signal. |

4.Quick Start

| | |
|--------------------|--|
| Update Firmware | The instrument firmware can be updated using a USB storage device through the front panel USB interface. |
|--------------------|--|

5. Communicate with PC

Supports communication with a computer via a USB port or a LAN port. Using the Waveform Editor software installed on the computer, the signal generator can be operated on the computer to control the output of the signal generator.

Here's how to connect to a computer. First, install the Waveform Editor software on the CD-ROM on your computer. Then, there are several connection options to choose from.

Using USB Port

- (1) **Set the USB device protocol type of the signal generator:** Press **Utility** → **I/O Setup** → **USBDEV** , switch to PC.
- (2) **Connection:** Connect the USB Device interface on the rear panel of the signal generator to the **USB interface** of the computer with a USB cable.
- (3) **Install the driver:** Run Waveform Editor software on the computer, press F1 to view the built-in help documentation. Follow the instructions to install the driver. The path of the driver is the USBDRV folder in the directory where the Waveform Editor communication software is located, such as "C:\Program Files (x86)\DS_Wave\Waveform Editor\USBDRV".
- (4) **Host computer communication port setting:** Open the Waveform Editor software, click "Communications" in the menu bar, select "Ports-Settings", in the setting dialog box, select the communication port as "USB". After the connection is successful, the connection status prompt in the lower right corner of the software interface turns green.

Using LAN Port

Connect Directly

- (1) **Connection.** Plug one end of the network cable into the LAN connector on the rear panel of the signal generator; the other end is plugged into the LAN interface of the computer.
- (2) **Set the network parameters of the computer.** Since the signal generator does not support automatic IP address acquisition, you need to specify the IP yourself. Here we set the IP address to 192.168.1.71.
- (3) **Set the network parameters of the host computer.** Run Waveform Editor software on the computer. In the "Communications" menu, under "Ports-Settings", select the communication port as "LAN", the IP is set to be the same as the first three fields of the computer's network IP in step (2),

and the last field has a different IP address. It is "192.168.1.99"; the port can be set to any value from 0 to 4000. However, since ports below 2000 are often occupied, it is recommended to set it to 2000 or higher. Here, it is set to "3000".

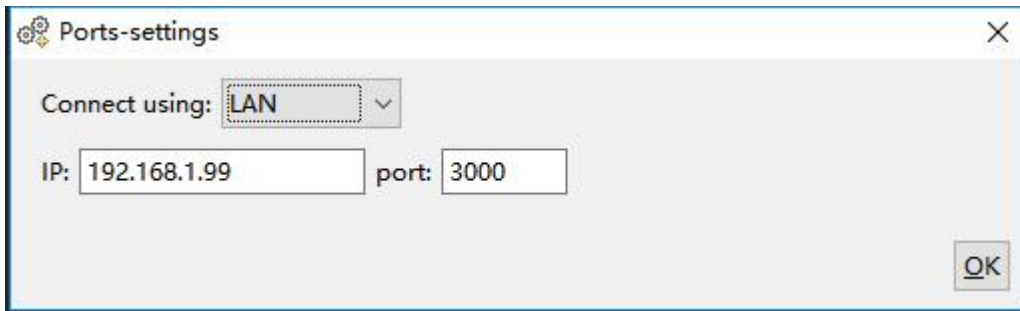

Figure 5-1: Setting the network parameters of the host computer

- (4) **Set the network parameters of the signal generator.** In the signal generator, press **Utility** → **I/O Setup** → **Network setting** to enter the submenu. Set the IP address and port to the IP and port in the PC software port settings in step (3). After the shutdown and restart, if the data can be obtained normally in the PC software, the connection is successful.

Connect through a Router

- (1) **Connection.** Connect the LAN interface on the rear panel of the signal generator to the router with a network cable. The computer is also connected to the router.
- (2) **Set the network parameters of the computer.** Since the signal generator does not support automatic IP address acquisition, you need to specify the IP yourself. The default gateway and subnet mask settings must match the settings of the router. For example, the IP address is set to 192.168.1.71, the subnet mask is set to 255.255.255.0, and the default gateway is set to 192.168.1.1.
- (3) **Set the network parameters of the host computer.** Run Waveform Editor software on the computer. In the "Communications" menu, under "Ports-Settings", select the communication port as "LAN", the IP is set to be the same as the first three fields of the computer's network IP in step (2), and the last field has a different IP address. It is "192.168.1.99"; the port can be set to any value from 0 to 4000. However, since ports below 2000 are often occupied, it is recommended to set it to 2000 or higher. Here, it is set to "3000".

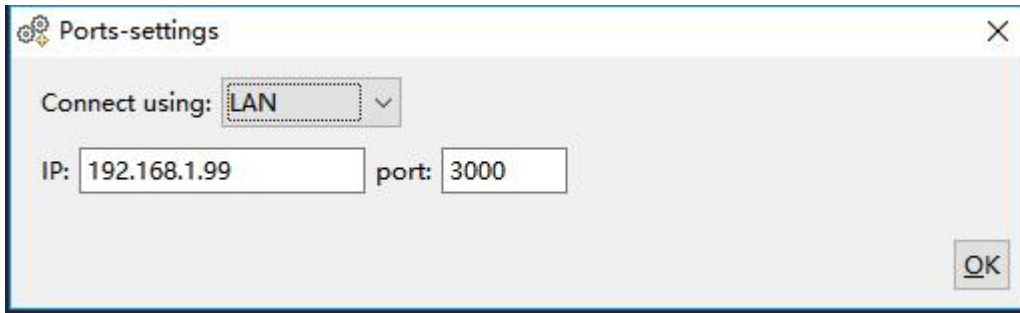

Figure 5- 1: Set the network parameters of the host computer

- (4) **Set the network parameters of the signal generator.** In the signal generator, press **Utility** → **I/O Setup** → **Network setting** to enter the submenu. Set the IP address and port to the IP and port in the PC software port settings in step (3). The gateway settings need to be the same as the gateway settings of the router. After the shutdown and restart, if the data can be obtained normally in the PC software, the connection is successful.

For the specific operation method of Waveform Editor software, please press F1 to view the built-in help documentation.

6. Appendix

Appendix A: Accessories

- 1 × power cord that meets the standards of the country where you are located
- 1 × USB communication cable
- 1 × CD with communication software
- 1 × Quick Guide
- 1 × BNC/Q9 cable

Appendix B: General Care and Cleaning

General Maintenance

Do not store or leave the instrument where the liquid crystal display will be exposed to direct sunlight for long periods of time.

Caution: To avoid any damage to the instrument or probe, do not exposed it to any sprays, liquids, or solvents.

Cleaning

Inspect the instrument and probes as often as operating conditions require. To clean the instrument exterior, perform the following steps:

1. Wipe the dust from the instrument and probe surface with a soft cloth. Do not make any scuffing on the transparent LCD protection screen when clean the LCD screen.
2. Disconnect power before cleaning your instrument. Clean the instrument with a wet soft cloth not dripping water. It is recommended to scrub with soft detergent or fresh water. To avoid damage to the instrument or probe, do not use any corrosive chemical cleaning agent

 **Warning:** Before power on again for operation, it is required to confirm that the instrument has already been dried completely, avoiding any electrical short circuit or bodily injury resulting form the moisture.
